

IC0603B820R-10

PHYSICAL DIMENSIONS:

A	1.60 [.063]	+ 0.15[.006]
B	0.80 [.031]	+ 0.15[.006]
C	0.80 [.031]	+ 0.15[.006]
D	0.30 [.012]	+ 0.20[.008]

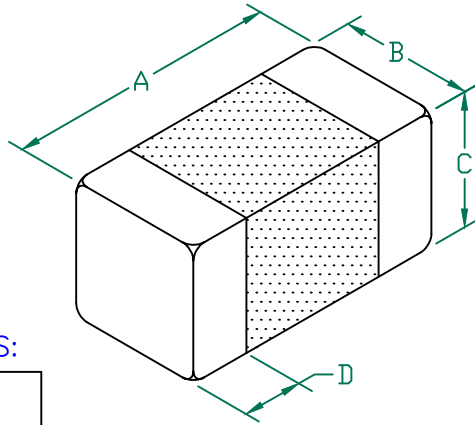

NOTES: UNLESS OTHERWISE SPECIFIED

1. TAPED AND REELED per CURRENT EIA SPECIFICATIONS 7" REELS, 4000 PCS/REEL, PAPER TAPE.
2. TERMINATION FINISH IS 100% MATTE Sn OVER Ni.
3. COMPONENTS SHOULD BE ADEQUATELY PREHEATED BEFORE SOLDERING.
4. I (MAX.) IS BASED ON THE MAXIMUM SUSTAINED CURRENT APPLIED WHILE MAINTAINING A MAXIMUM TEMPERATURE RISE OF 40°C OVER AMBIENT.
5. OPERATING TEMP. RANGE: -40°C~+125°C. (INCLUDING SELF-HEATING)

ELECTRICAL CHARACTERISTICS:

L (nH) ± 10%	90	Max
	82	Nom
	74	Min
Q (Min)	10	
Freq. (MHz)	50	
Self-Resonant Freq (MHz)	245	
DCR(Max) Ω	0.30	
I (Max)	250mA	

LAND PATTERNS FOR REFLOW SOLDERING

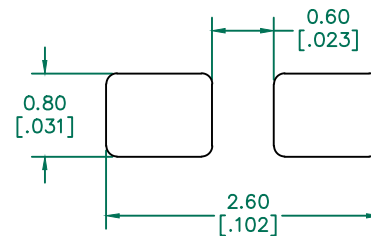

(For wave soldering, add 0.762[.030] to this dimension)

RECOMMENDED SOLDERING CONDITIONS

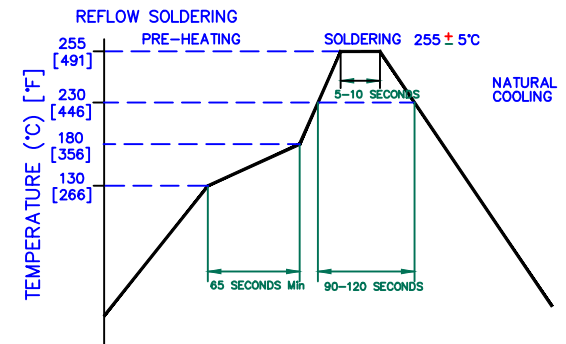

DIMENSIONS ARE IN mm [INCHES].				This print is the property of Laird Tech. and is loaned in confidence subject to return upon request and with the understanding that no copies shall be made without the written consent of Laird Tech. All rights to design or invention are reserved.				Laird	
D	REMOVE NOTE 5	07/21/16	QIU	PROJECT/PART NUMBER:	REV	PART TYPE:	DRAWN BY:		
C	ADD OPERATING TEMPERATURE UPDATE LAIRD LOGO AND REFLOW CURVE	08/05/13	QU	IC0603B820R-10	D	CO-FIRE	JRK		
B	UPDATE COMPANY LOGO	06/17/08	JRK	DATE:	12/27/06	SCALE:	NTS	SHEET:	
A	ORIGINAL DRAFT	12/27/06	JRK	CAD #	IC0603B820R-10-D	TOOL #	-		1 of 1
REV	DESCRIPTION	DATE	INT						