

MGHS High Operation Temperature Molded SMT Power Inductor MGHS1004 Series

FEATURES AND APPLICATIONS

Laird MGHS series high current power inductors improve performance, reliability and power efficiency. A lower profile benefits automotive and any general electronic design. Products feature extremely high reliability with greater efficiency and enable a large current in a small size. Inductors are of magnetic shielding and molded construction and perform in operating temperatures ranging from -55 C to 155 C including self-heating rise in temperature.

FEATURES

- High saturation current and soft saturation
- Metal alloy molded, robust and self-shielded construction
- Low profile and very compact in size
- Low DCR and high efficiency
- Automotive grade, high reliability and meets AEC-Q200

APPLICATIONS

- Automotive DC to DC power lines ,ADAS /Engine Control units / xEV Converters & Inverters
- Automotive noise suppression for motors in Seats / Mirrors / Blowers / Wipers
- General automotive application , LED Driver / Infotainment / Telematics Box /HUD /BMS /BCM
- General DC to DC power lines



PART NUMBER EXPLANATION

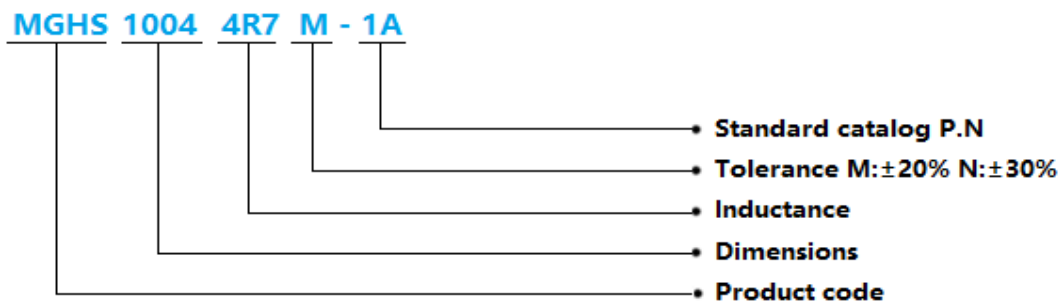

ELECTRICAL SPECIFICATIONS

- Inductance tested at 100KHz, 0.25V
- Heat Rated Current (Irms) is defined based on temperature rise approximate 40°C without core loss (ambient temperature 25±5°C)
- Saturation Current (Isat) is the DC current at which the inductance drops off approximately 30% from its value without current. (ambient temperature 25±5°C)
- Operating temperature range: -55°C~+155°C (including self-heating temperature rise)
- Storage temperature range (packaging conditions): -10°C~+40°C and RH 60%(MAX.)

Note: Heat Rated Current (Irms) is tested on a typical PCB and apply a constant current in still air. The temperature rise is dependent on the application system condition including PCB PAD pattern, trace width and thickness and adjacent components etc. It's suggested to verify the temperature rise of the component under the real operation application conditions.

Rev	Items	Before	After	Owner	Date
A	—	—	—	Denny	2021.10.27

1.MGHS1004 SERIES DIMENSIONS

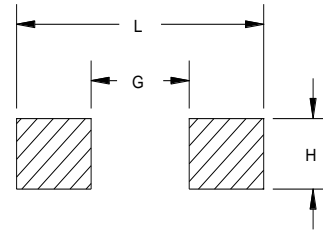
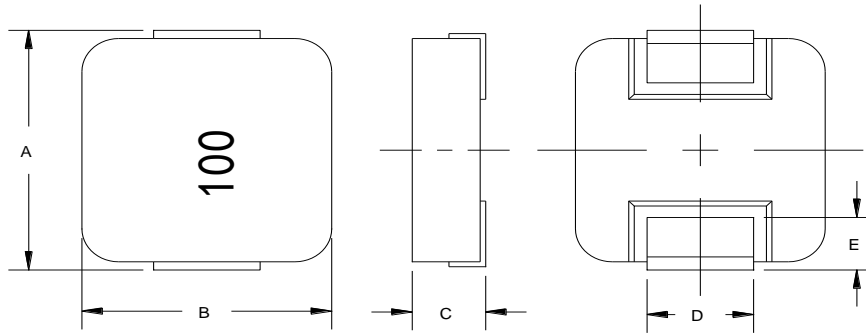

Recommended layout

MGHS1004 Series

A	B	C	D	E	L	G	H
11.0±0.5	10.0±0.3	3.8±0.3	3.0±0.5	2.0±0.5	12.2 ref	5.8 ref	4.1 ref

2.SPECIFICATION

PART NUMBER	INDUCTANCE (uH)	I _{rms} (A) Typ.	I _{sat} (A) Typ.	DCR(mΩ) Typ	DCR(mΩ) Max	REMARK
MGHS1004R22M-1A	0.22±20%	32.00	55.00	0.90	1.00	
MGHS1004R68M-1A	0.68±20%	23.00	30.00	2.10	2.40	
MGHS10041R0M-1A	1.0±20%	18.00	28.00	3.00	3.30	
MGHS10041R5M-1A	1.5±20%	15.00	26.00	3.80	4.20	
MGHS10042R2M-1A	2.2±20%	12.00	18.00	6.00	7.00	
MGHS10043R3M-1A	3.3±20%	10.00	16.00	10.80	11.80	
MGHS10044R7M-1A	4.7±20%	8.50	13.00	17.00	20.00	
MGHS10046R8M-1A	6.8±20%	7.00	10.00	22.50	25.00	
MGHS1004100M-1A	10.0±20%	6.50	8.50	27.00	30.00	
MGHS1004150M-1A	15.0±20%	6.25	7.00	40.00	45.00	
MGHS1004220M-1A	22.0±20%	5.00	5.50	60.00	66.00	
MGHS1004330M-1A	33.0±20%	4.00	4.50	85.00	92.00	
MGHS1004470M-1A	47.0±20%	3.30	3.50	130.00	145.00	
MGHS1004680M-1A	68.0±20%	2.00	3.00	195.00	210.00	

3.EQUIVALENT CIRCUIT

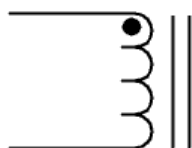

4.MATERIAL LIST

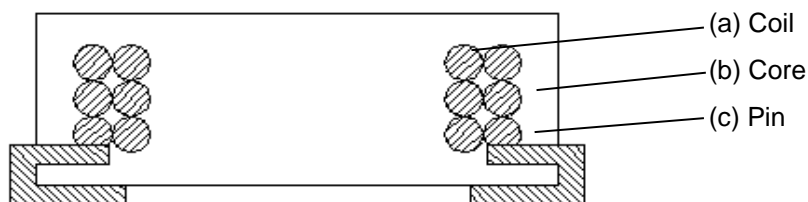

5. CHARACTERISTICS CURVES

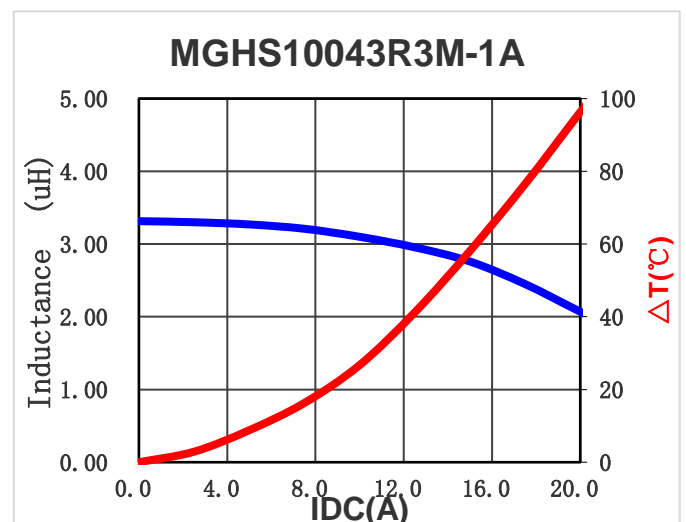
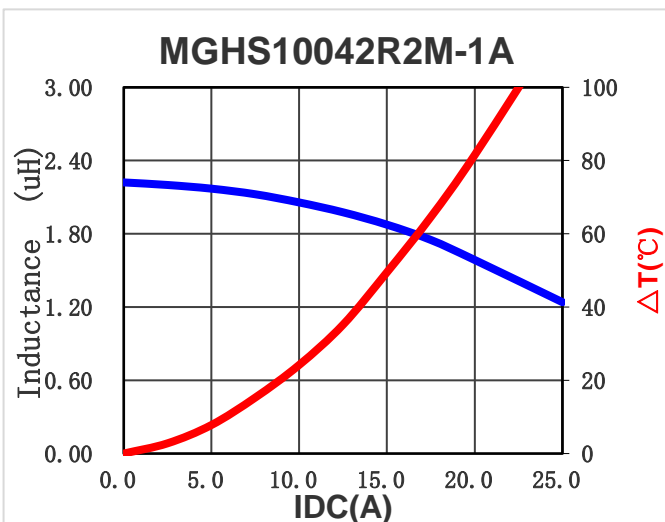
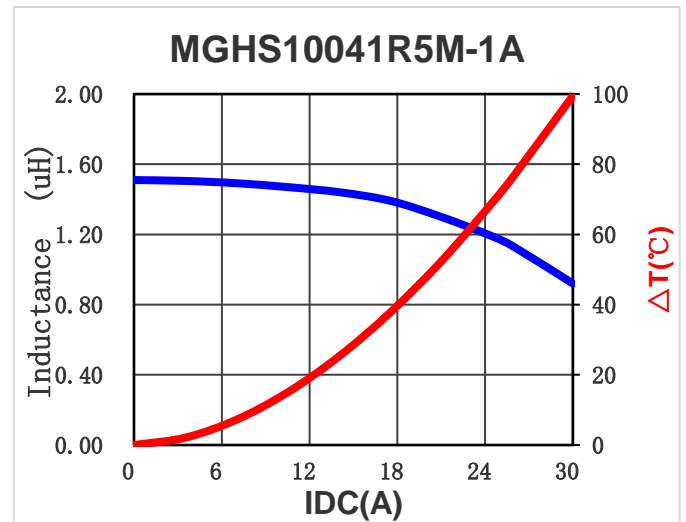
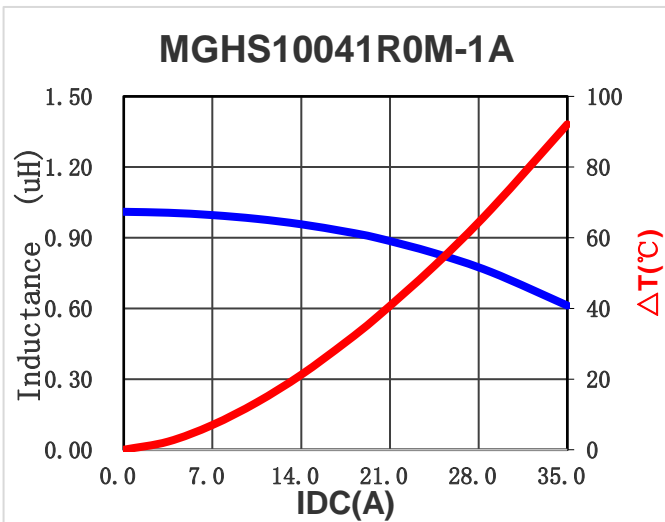
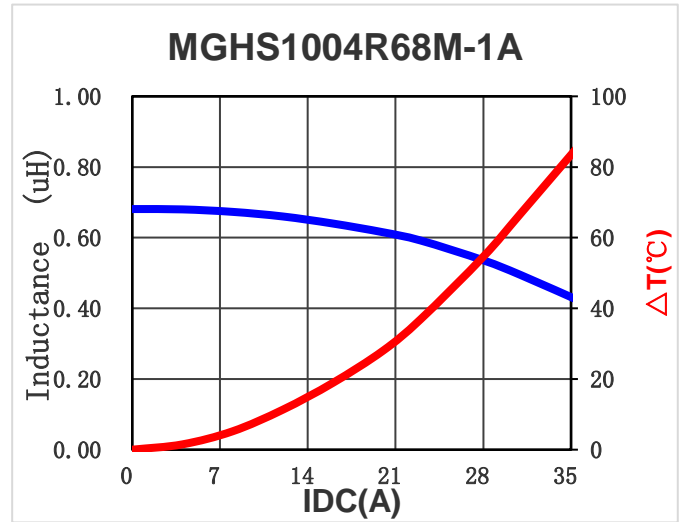
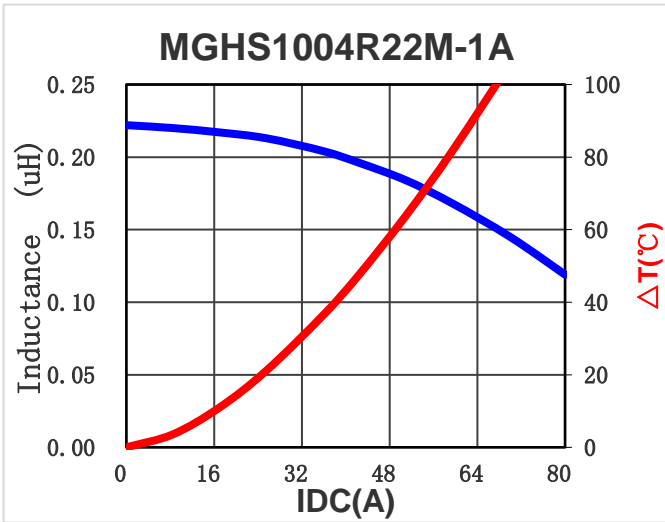

5. CHARACTERISTICS CURVES

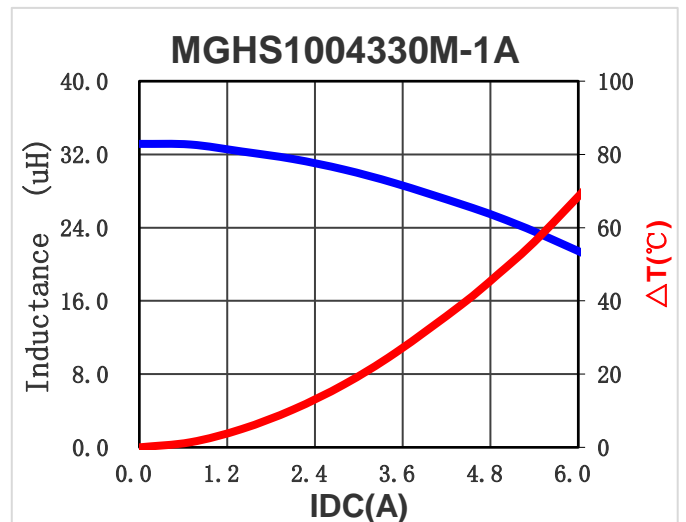
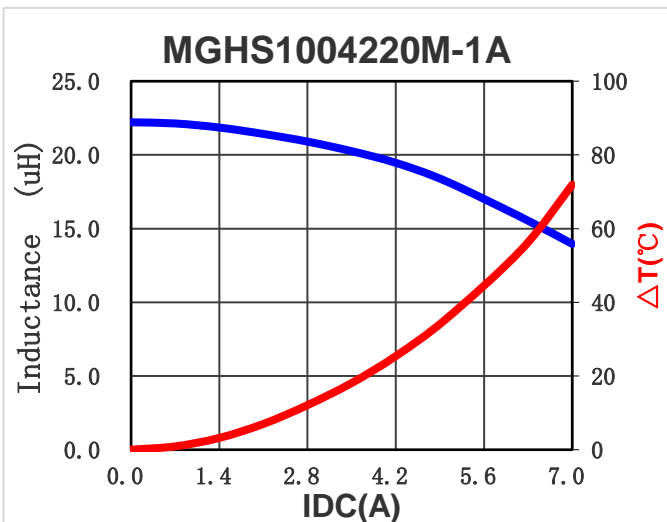
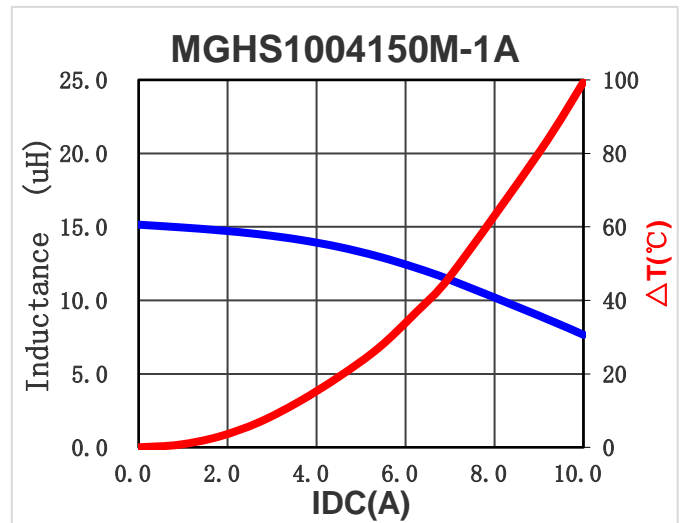
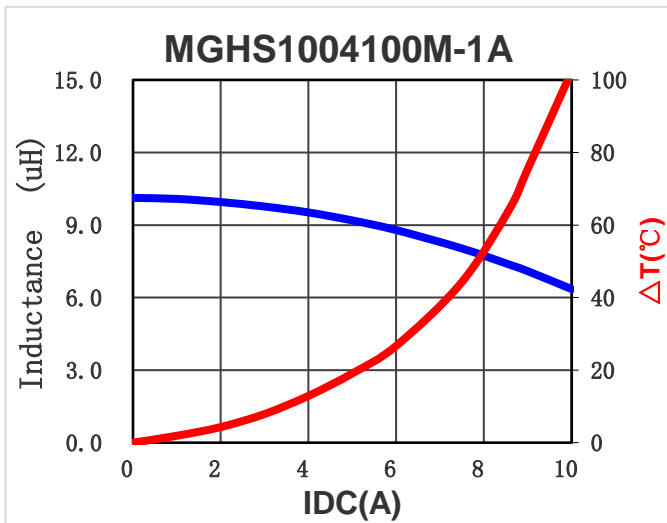
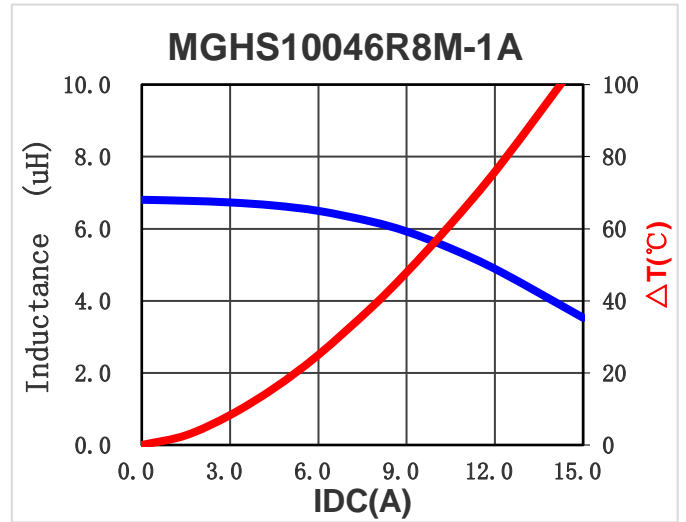
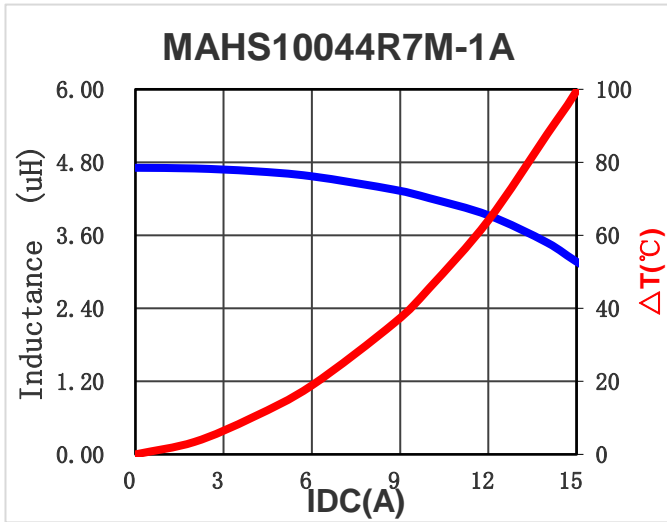

5. CHARACTERISTICS CURVES

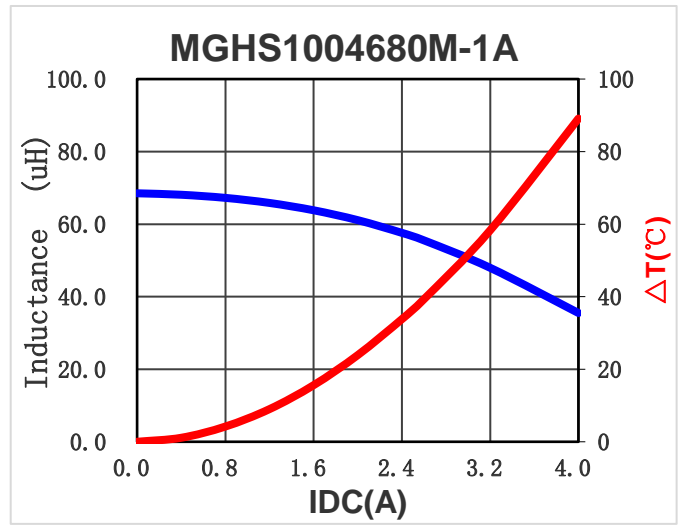
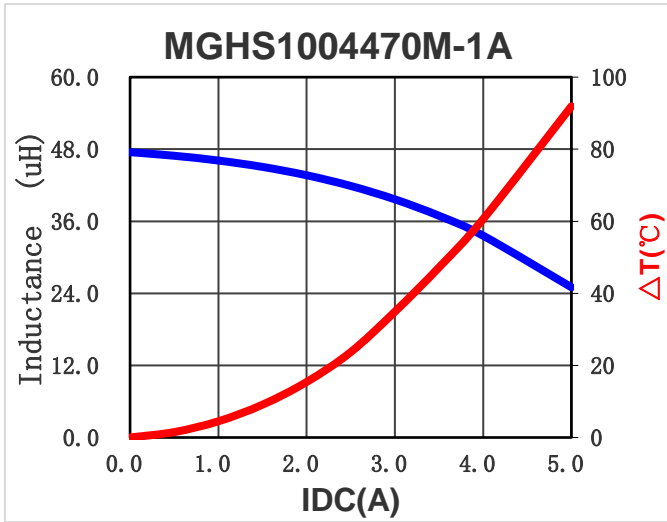

6. SOLDERING

Mildly activated rosin fluxes are preferred.

Recommended temperature profiles for re - flow soldering in Figure 1 .

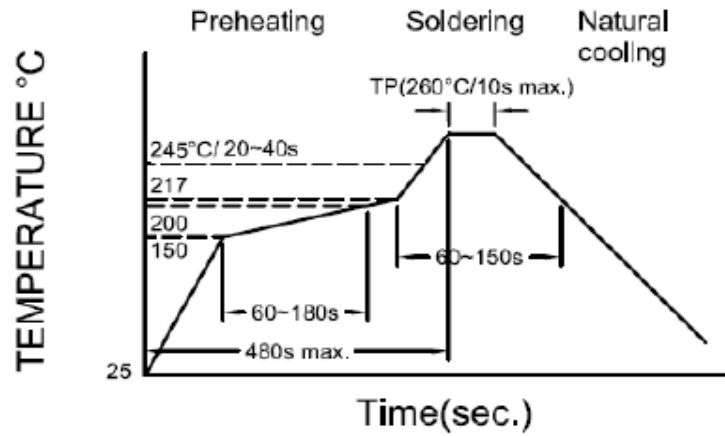
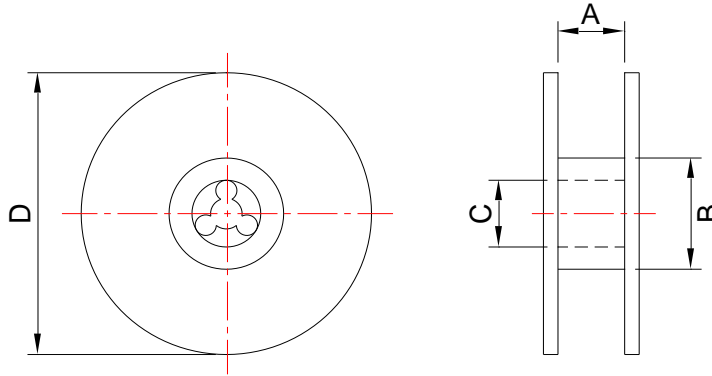

Figure 1. : Re-flow Soldering time
3 times Max.

7. PACKAGING

7-1 Reel Dimension



Type	A(mm)	B(mm)	C(mm)	D(mm)
13'x24	24.4+2/-0	100 ± 2	13+0.5/-0.2	330

7-2 Tape Dimension

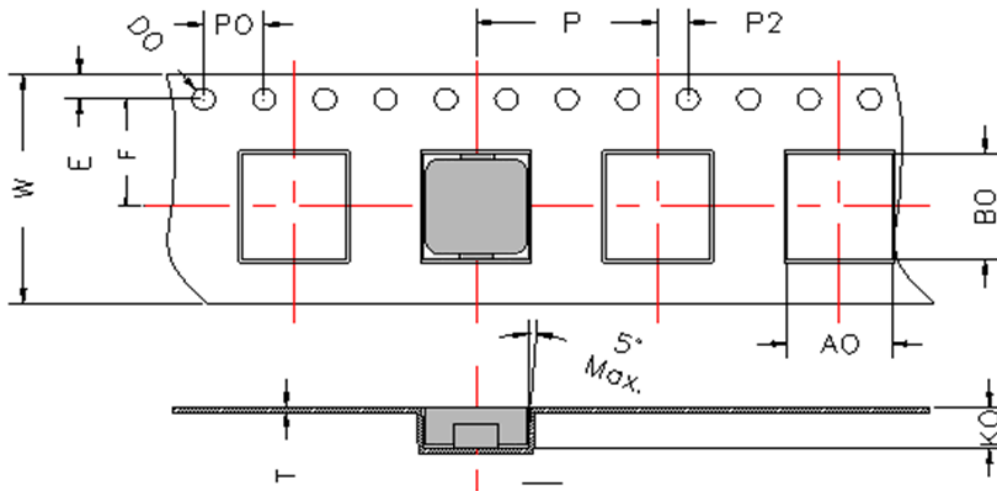

W	E	F	P	A0	B0	P2	P0	K0	t	D0
24.0±0.3	1.75±0.1	11.50±0.1	16.00±0.1	10.4±0.1	11.60±0.1	2.0±0.1	4.0±0.1	4.2±0.1	0.35±0.05	1.5Ref.

Size	Reel	Inner Box	Outer Box
MGHS1004	500	1000	2000

7-3 Tearing Off Force

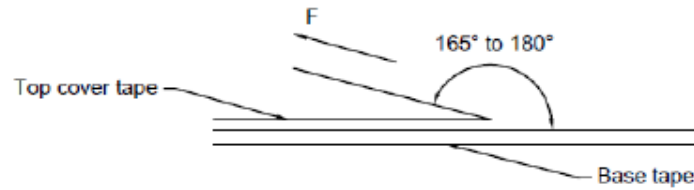

The force for tearing off cover tape is 10~100 grame in the arrow direction under the following conditions .

Room Temp (°C)	Room Humidity(%)	Room atm (hPa)	Tearing Speed mm/min
5~35	45~85	860~1060	300

8. Application Notice:

1.Storage Conditions:

To maintain the solderability of terminal electrodes:

- a) Recommended products should be used within 12 months from the time of delivery .
- b) The packaging materal should be kept where no chlorine or sulfur exists in the air .

2. Transportation:

- a) Products should be -handled with care to avoid damage or contamination from perspiration and skin oils .
- b) Vacuum pick up is strongly recommended for individual components .
- c) Bulk handling should ensure that abrasion and mechanical shock are minimized .

9. Cosmetic Specification

- a.Cosmetic Specification refer to Laird WI-QA-143