

CONFIDENTIAL & PROPRIETARY

THIS INFORMATION IS CONFIDENTIAL AND PROPRIETARY TO LAIRD TECHNOLOGIES. IT MAY NOT BE DISCLOSED TO ANYONE, OTHER THAN LAIRD TECHNOLOGIES PERSONNEL, WITHOUT WRITTEN AUTHORIZATION FROM LAIRD TECHNOLOGIES.

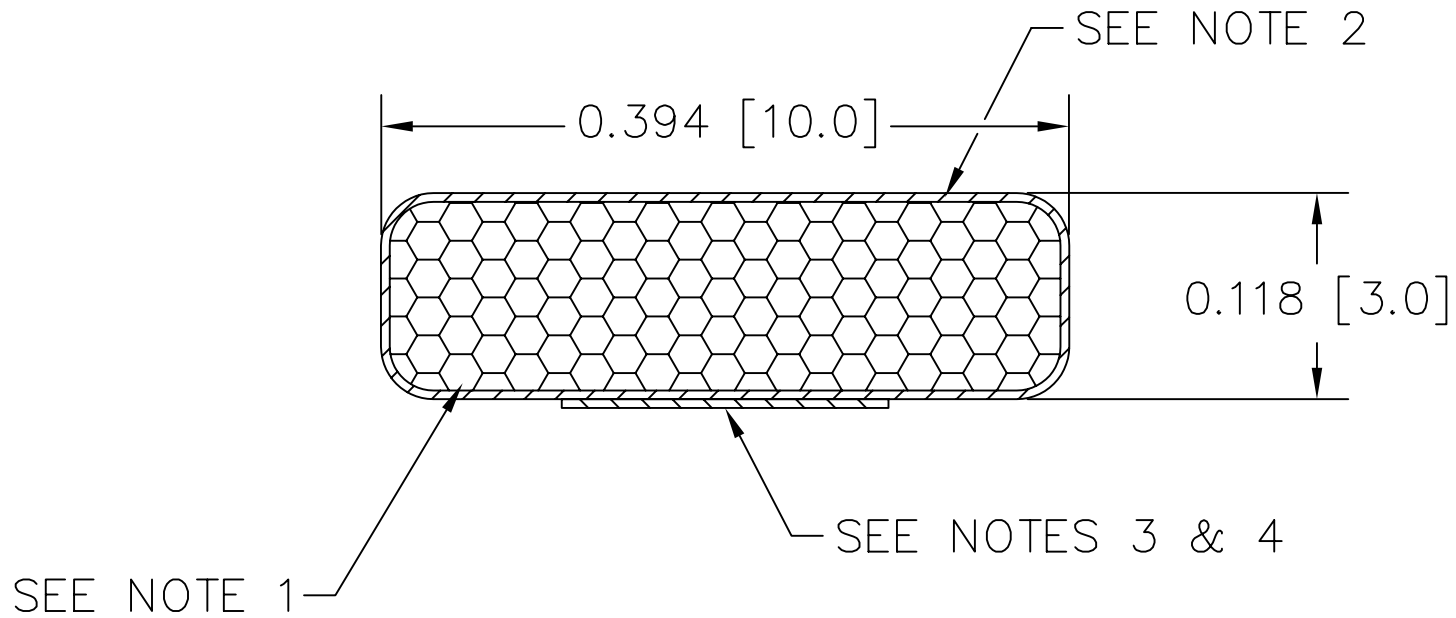

NOTES:

1. FOAM: POLYURETHANE
2. FABRIC: NICKEL PET-TAF FR Ecogreen
3. TAPE: .187" TAPE HI-TEMP
4. LINER: NO EXTENDED RELEASE LINER
5. FABRIC SEAM LOCATION MAY VARY.
6. CARRIER: NO CARRIER
7. THIS PART IS RoHS COMPLIANT

REVISIONS:	TITLE:		DRAWN	DATE	SCALE:	DIMENSIONS ARE IN INCHES. UNLESS OTHERWISE SPECIFIED, TOLERANCES ARE AS FOLLOWS:	
	SHIELDING GASKET		GIBILTERRA	10/2/07	1/1		
	Dwg. or Part No.		CHECKED BY:	DATE	DECIMALS		LENGTH
	4286-PA-51H		FJG	10/02/07	.XX ± .03		0" - 6" ± .030"
	REV.	RELEASED BY:	DATE	.XXX ± .020	6" - 11" ± .050"		
	0	FJG	10/02/07	ANGLES	11" - 48" ± .100"		
				± 1/2"	48" - 70" ± .187"		
					70" - 144" ± .250"		

